

Dear Customer

Very important Please Note:

Your new cabinet has an Infra-red sensor on the bottom of the rear carcass.

There needs to be at least a 15cm gap between the head of the sensor and the nearest obstacle, a wall for example.

If the gap is less than 15cm then your sensor will not work properly!

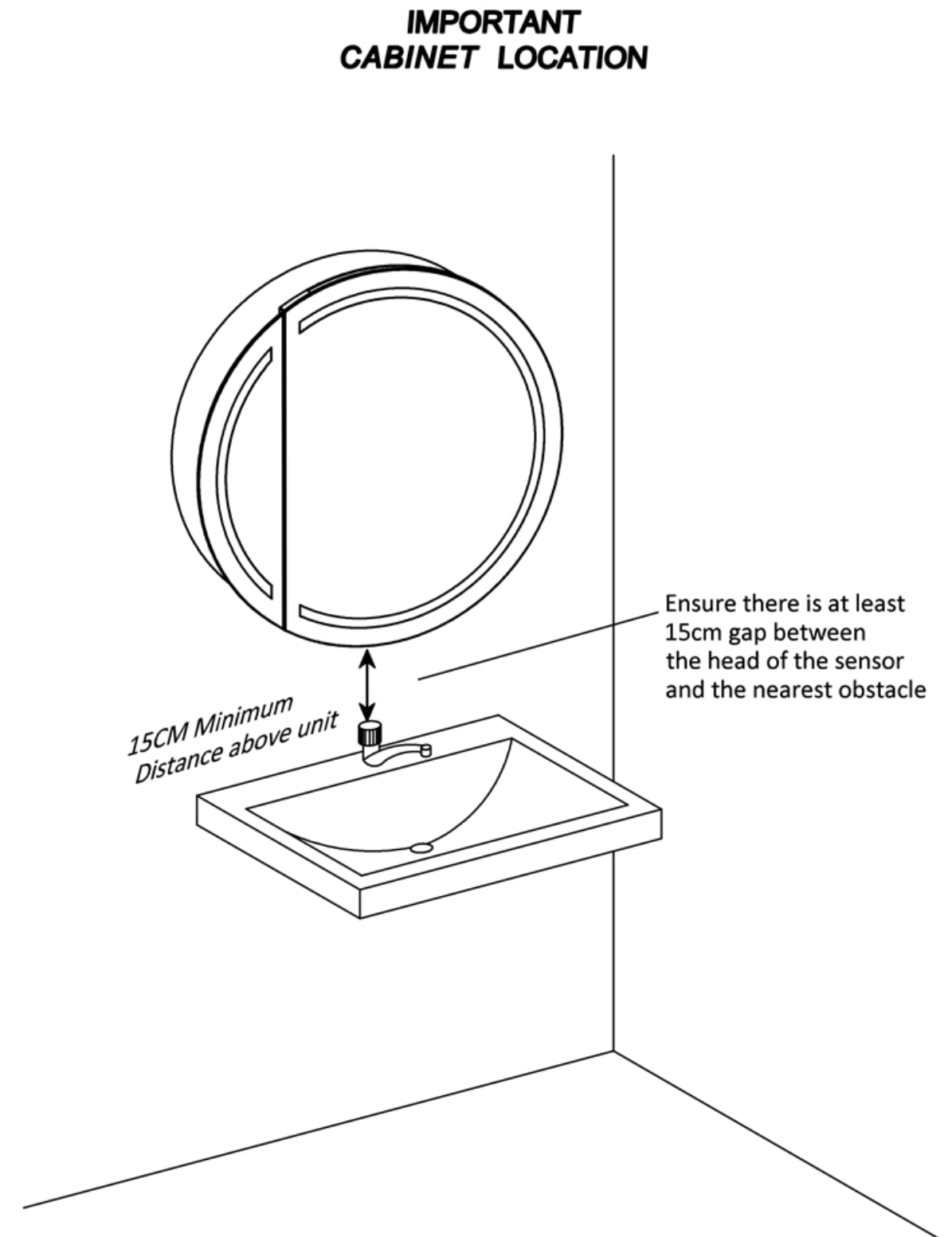

The line drawings for BL10.060/GR10.060

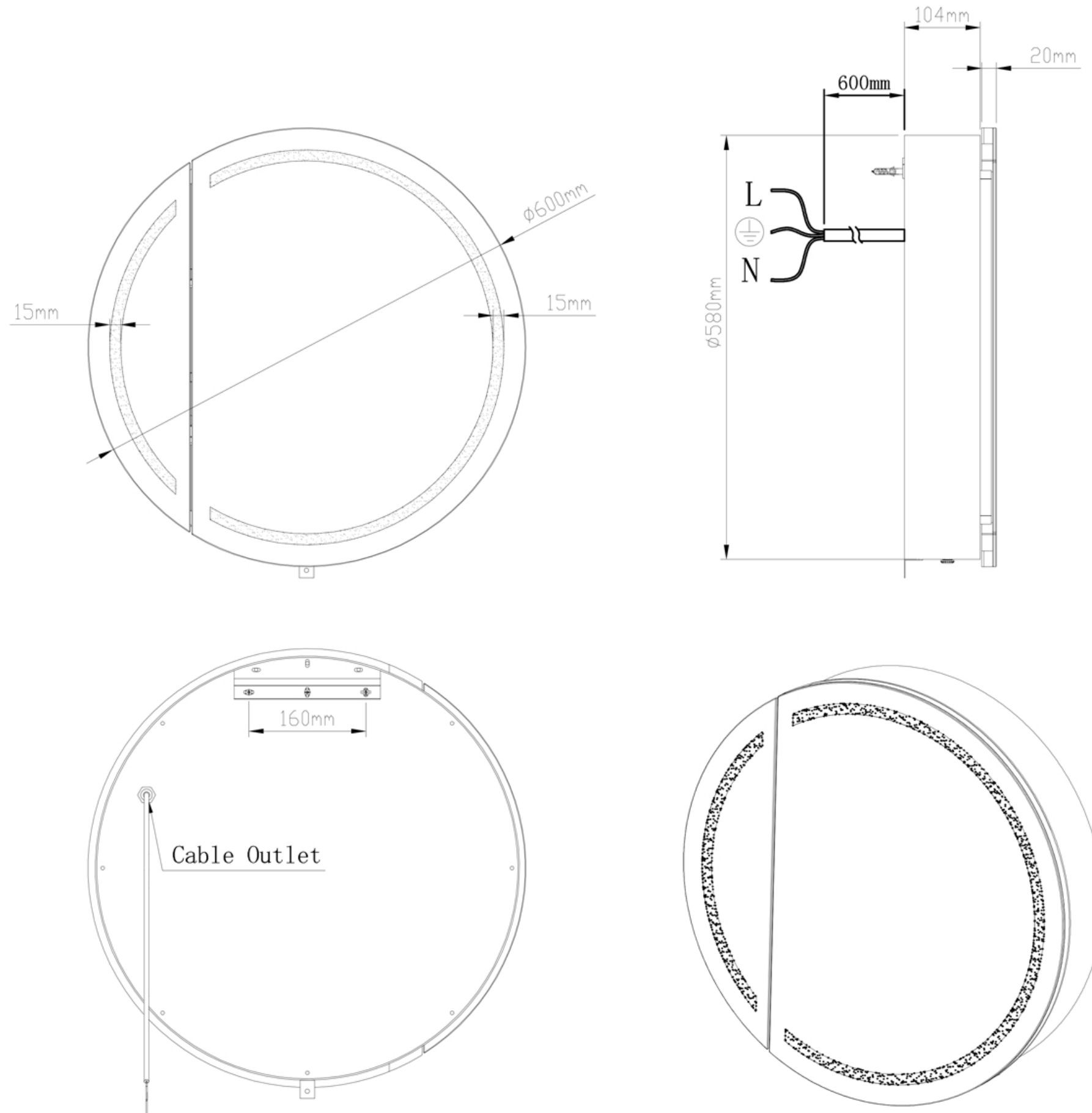

INSTALLATION INSTRUCTIONS

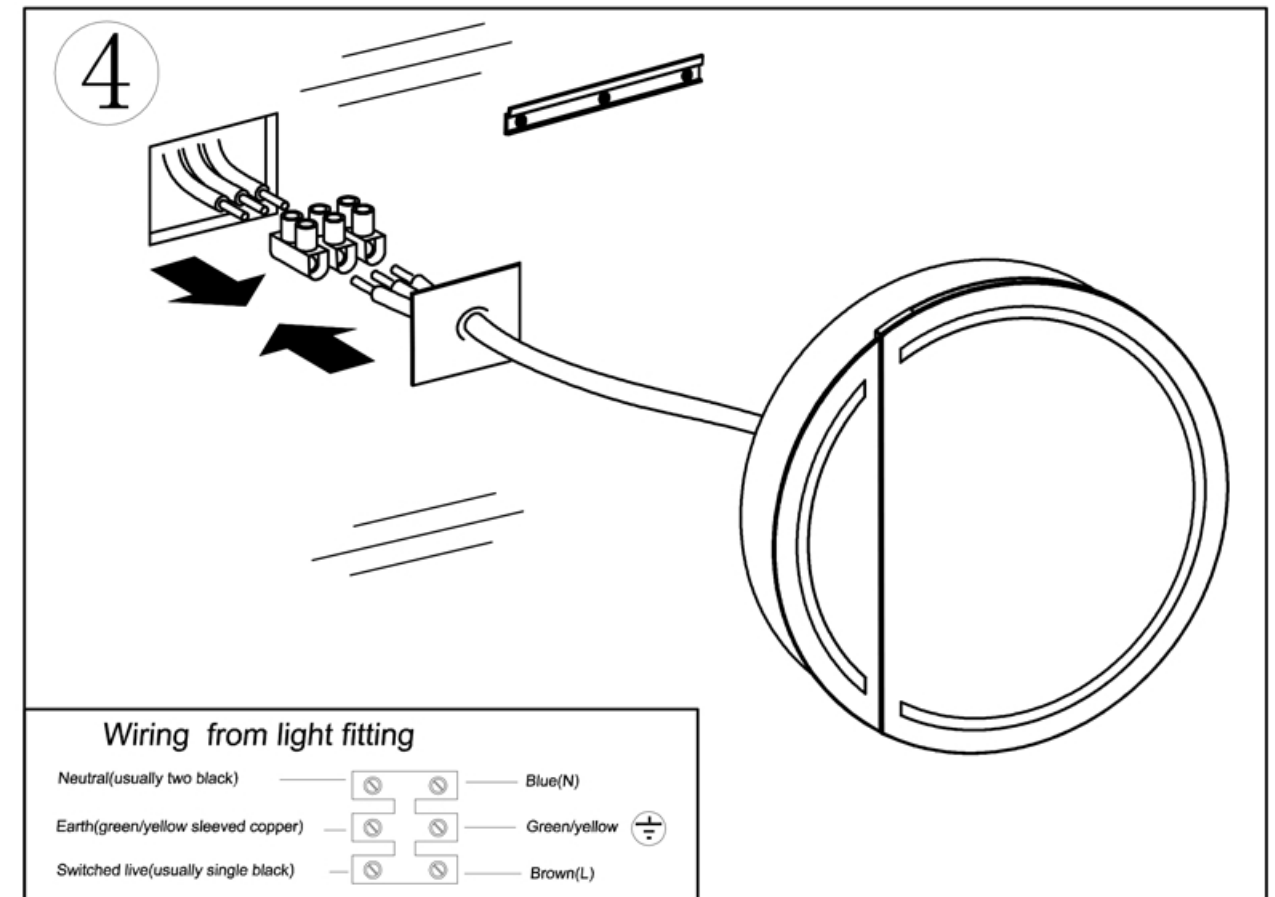
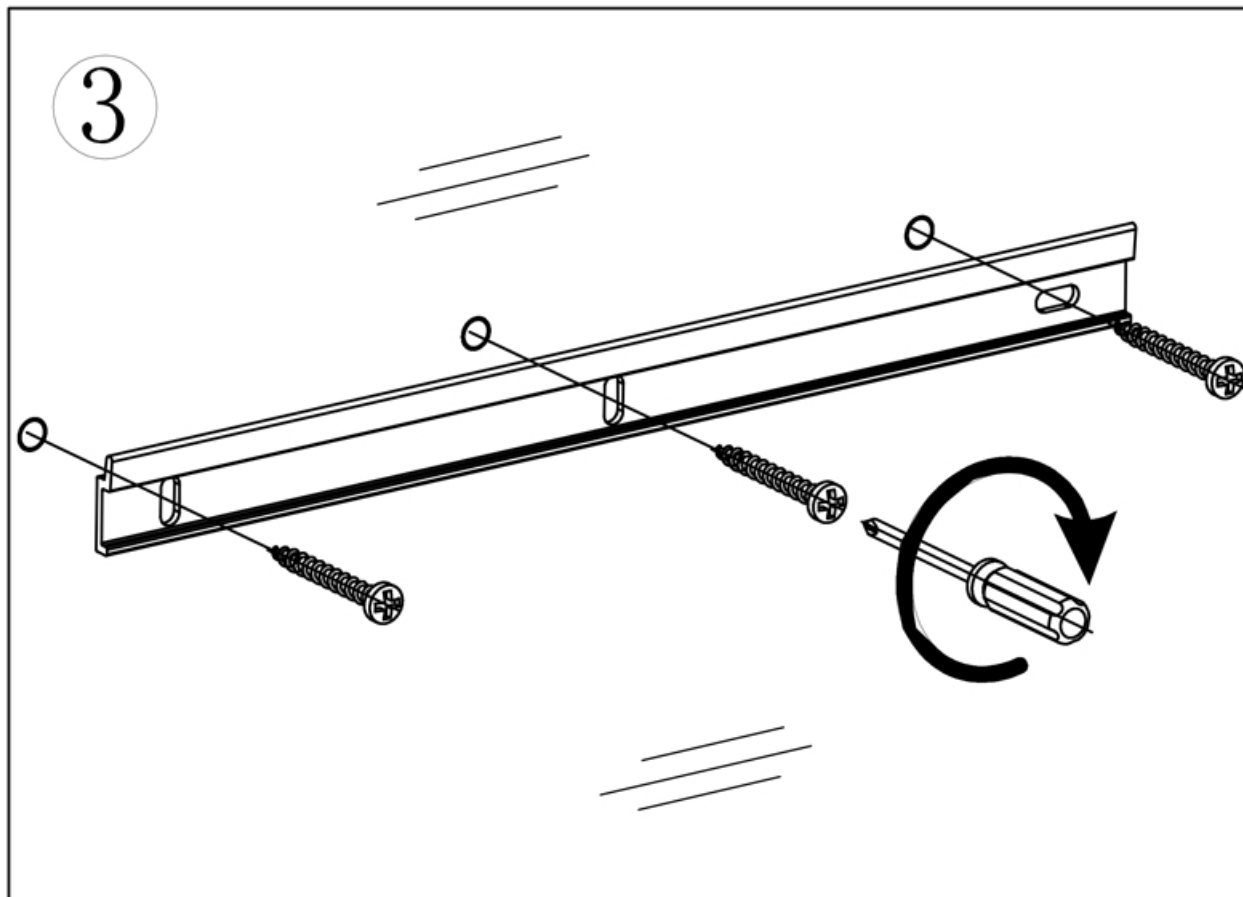
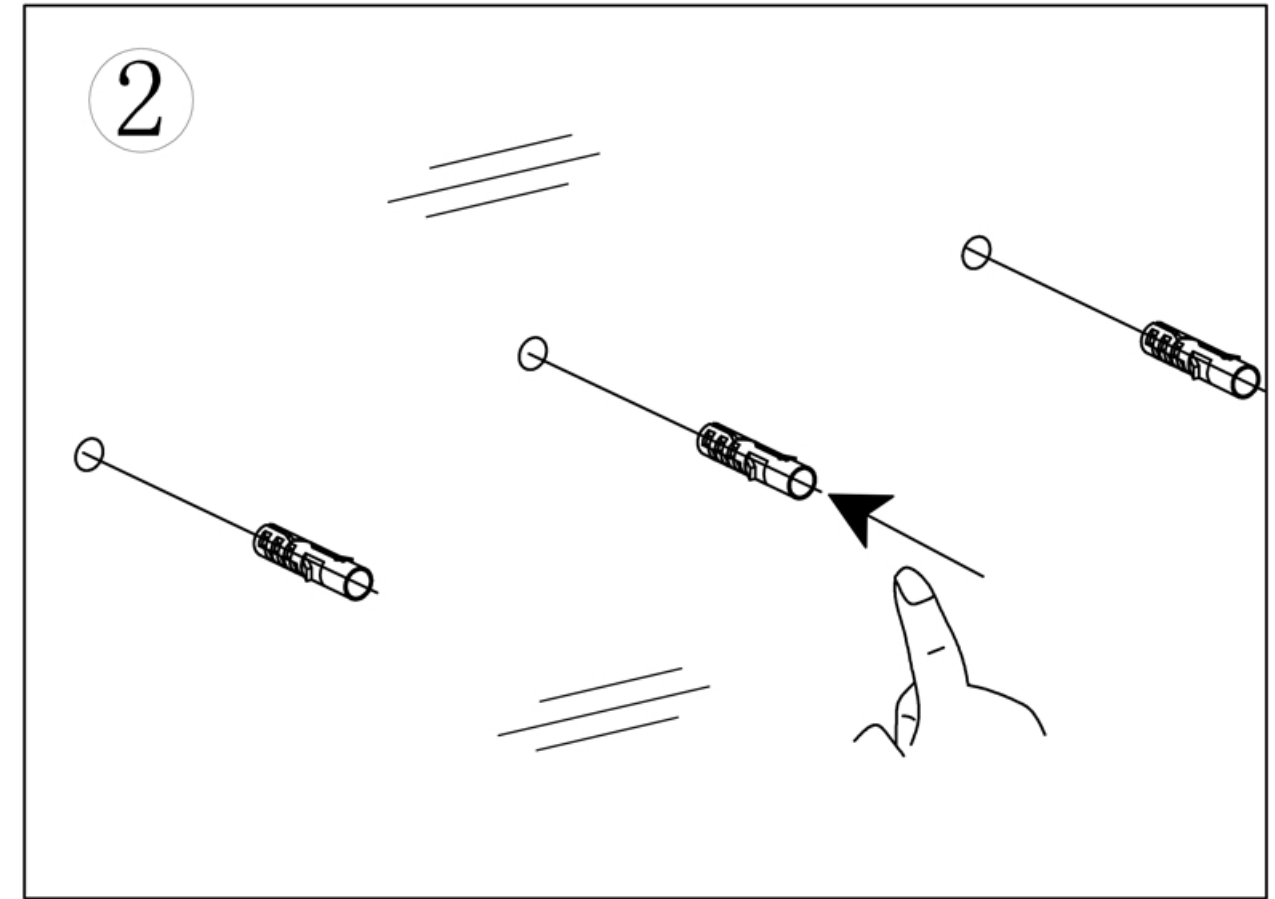
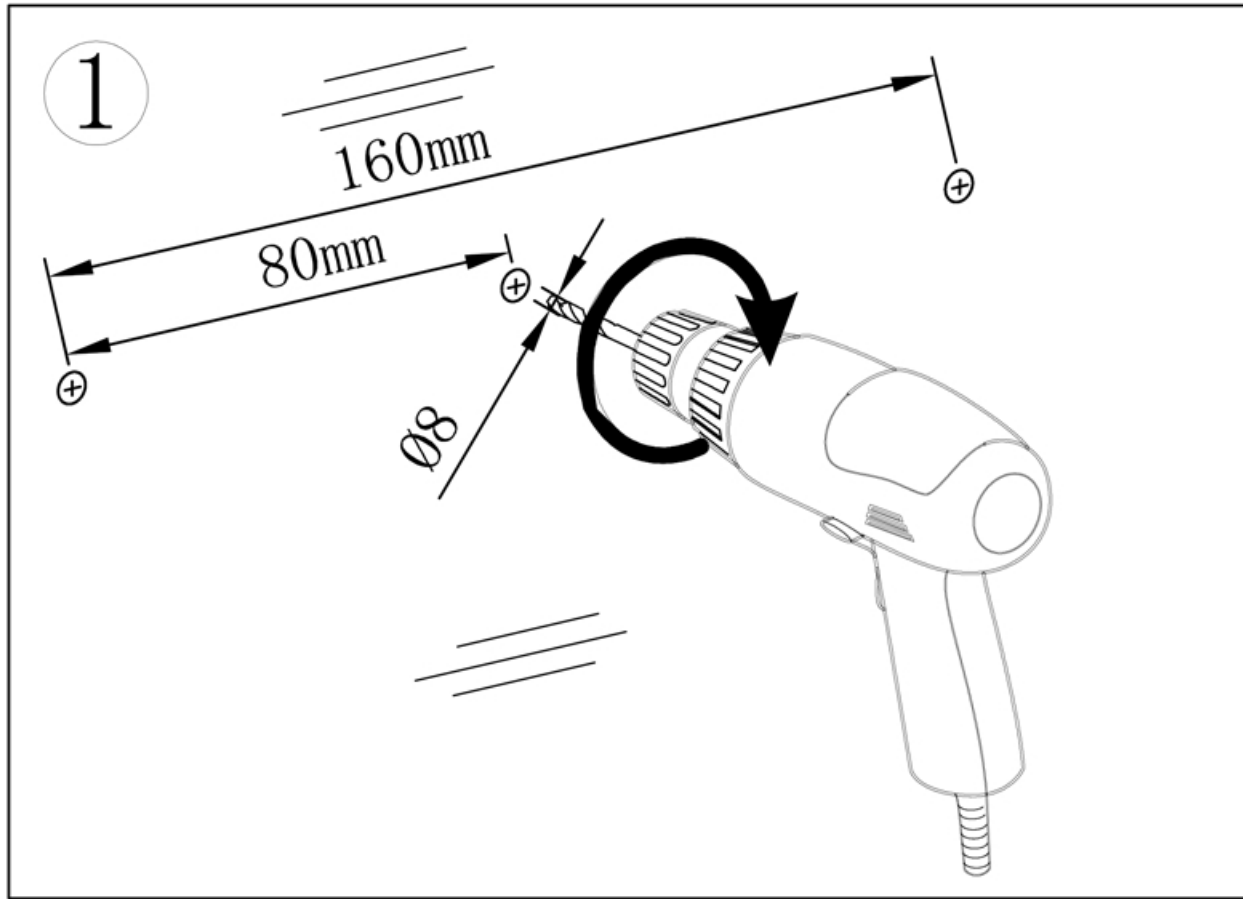

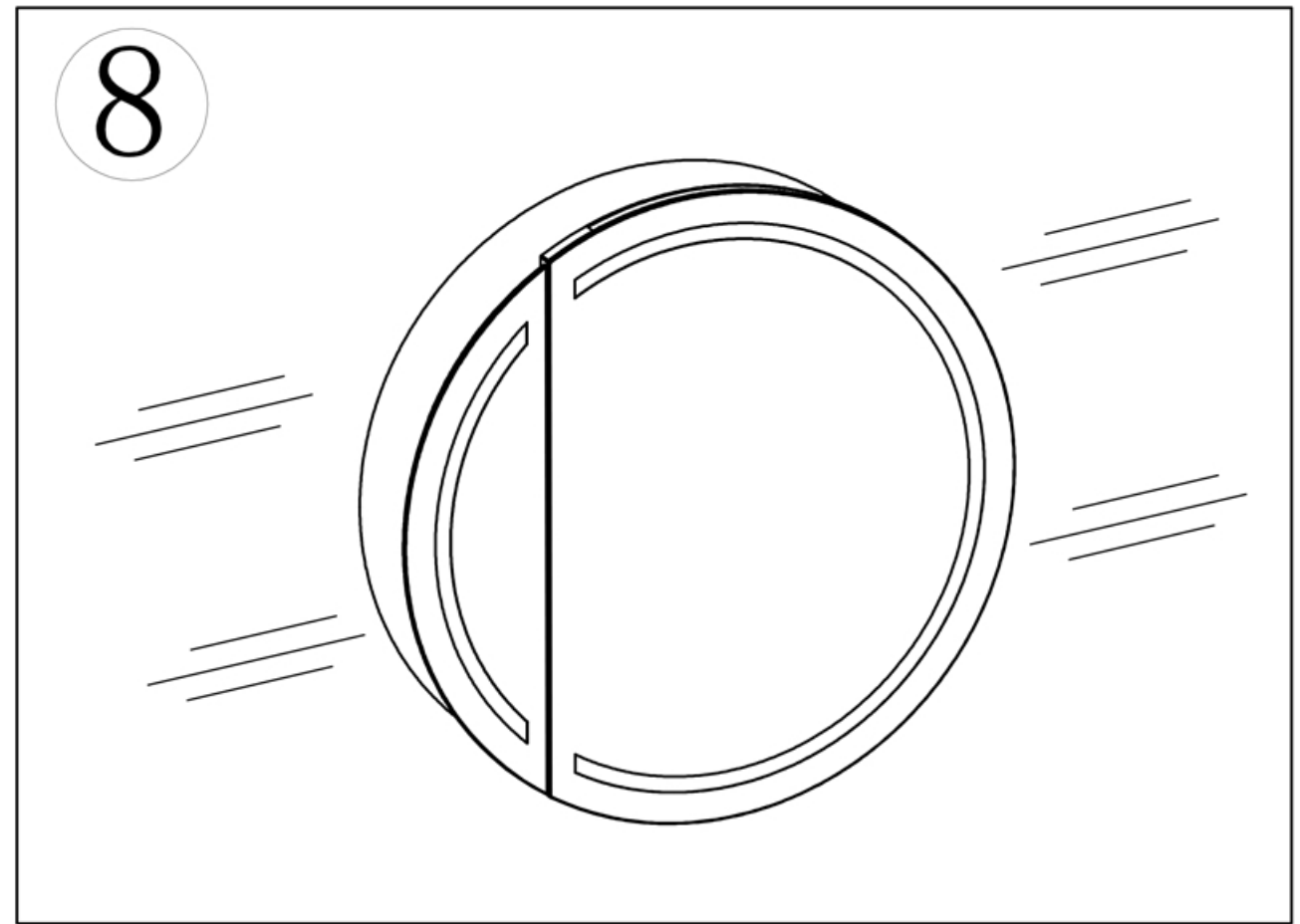
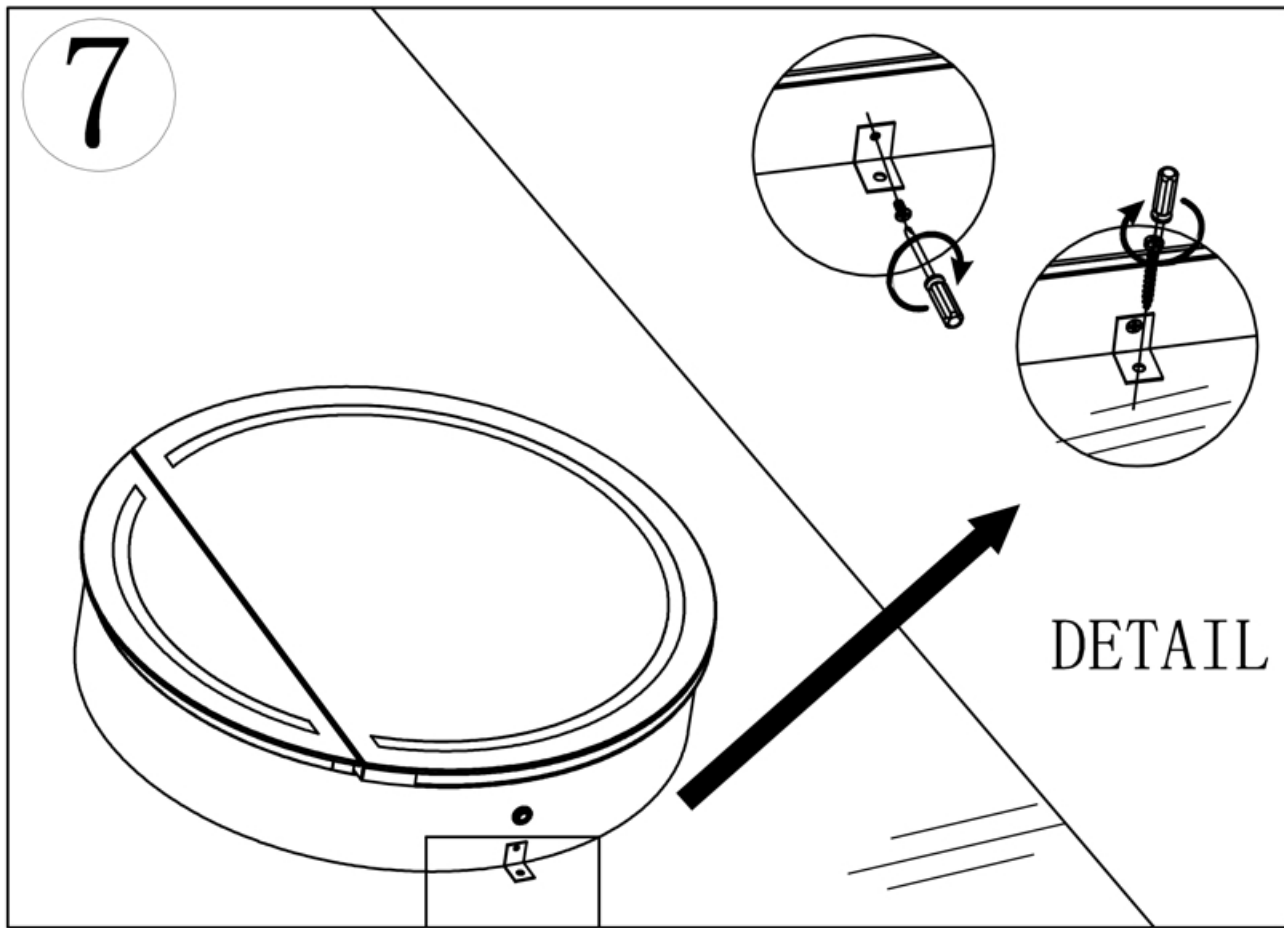
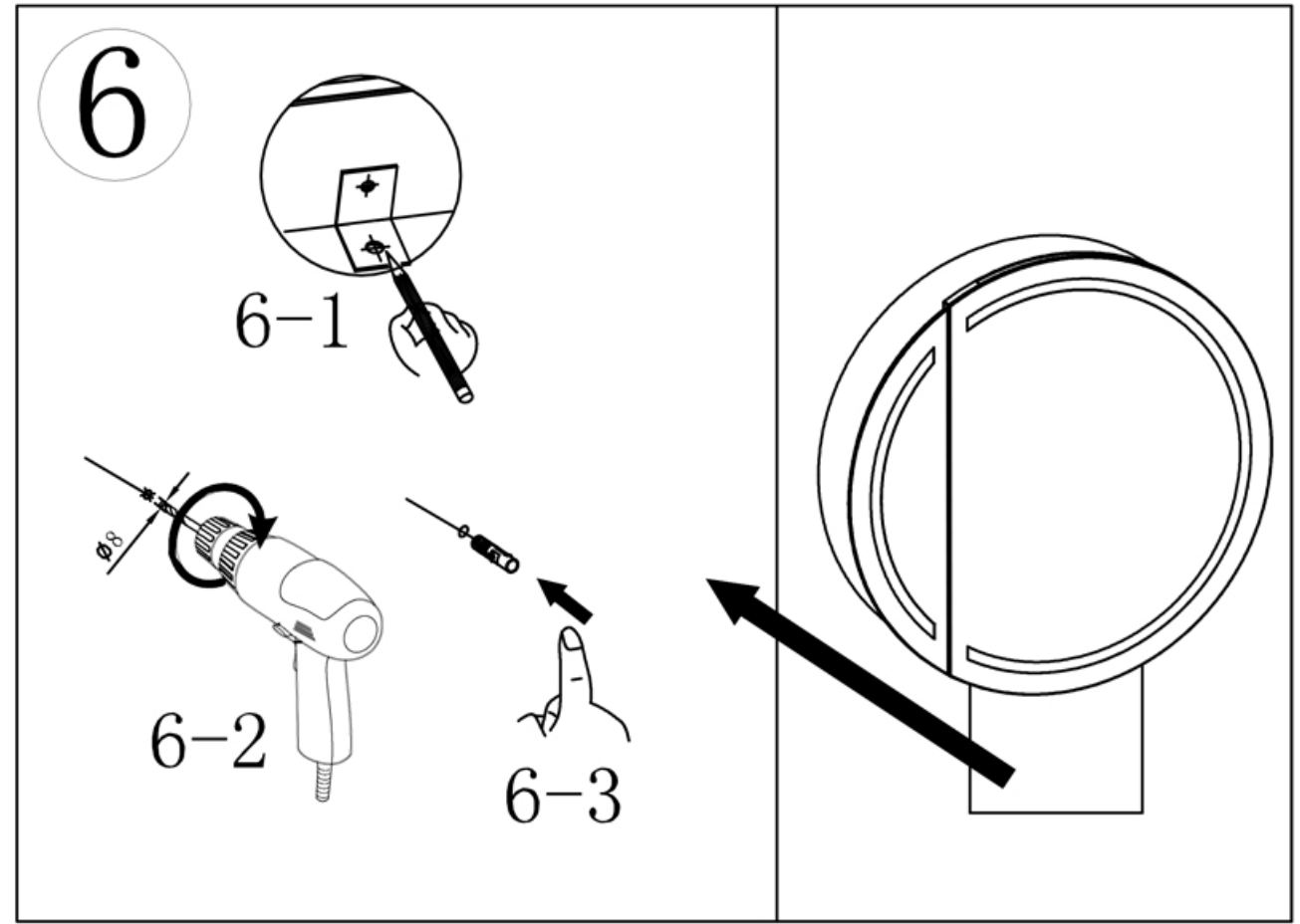
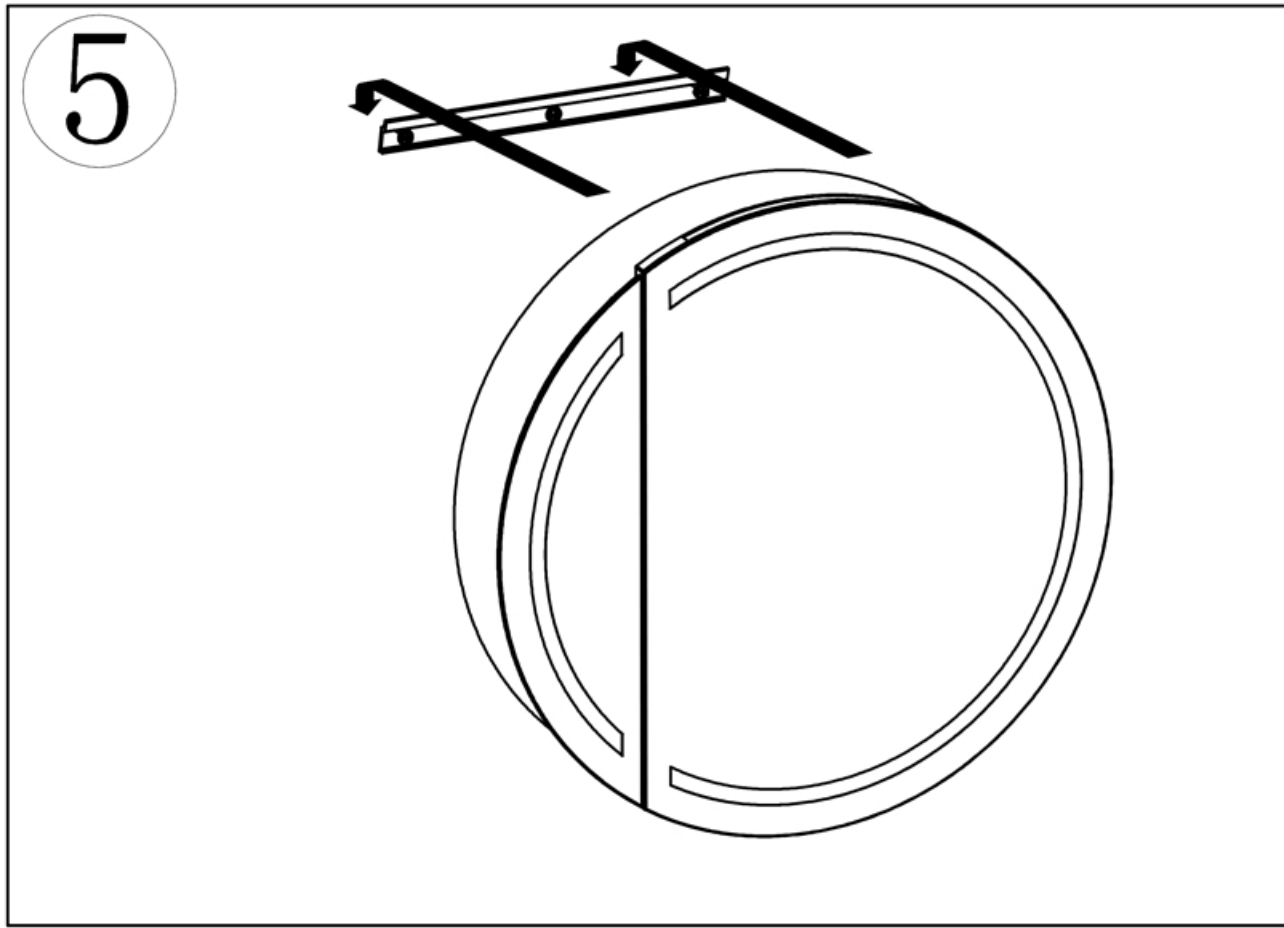

FIXING INSTRUCTIONS FOR THE ADJUSTABLE GLASS SHELVES

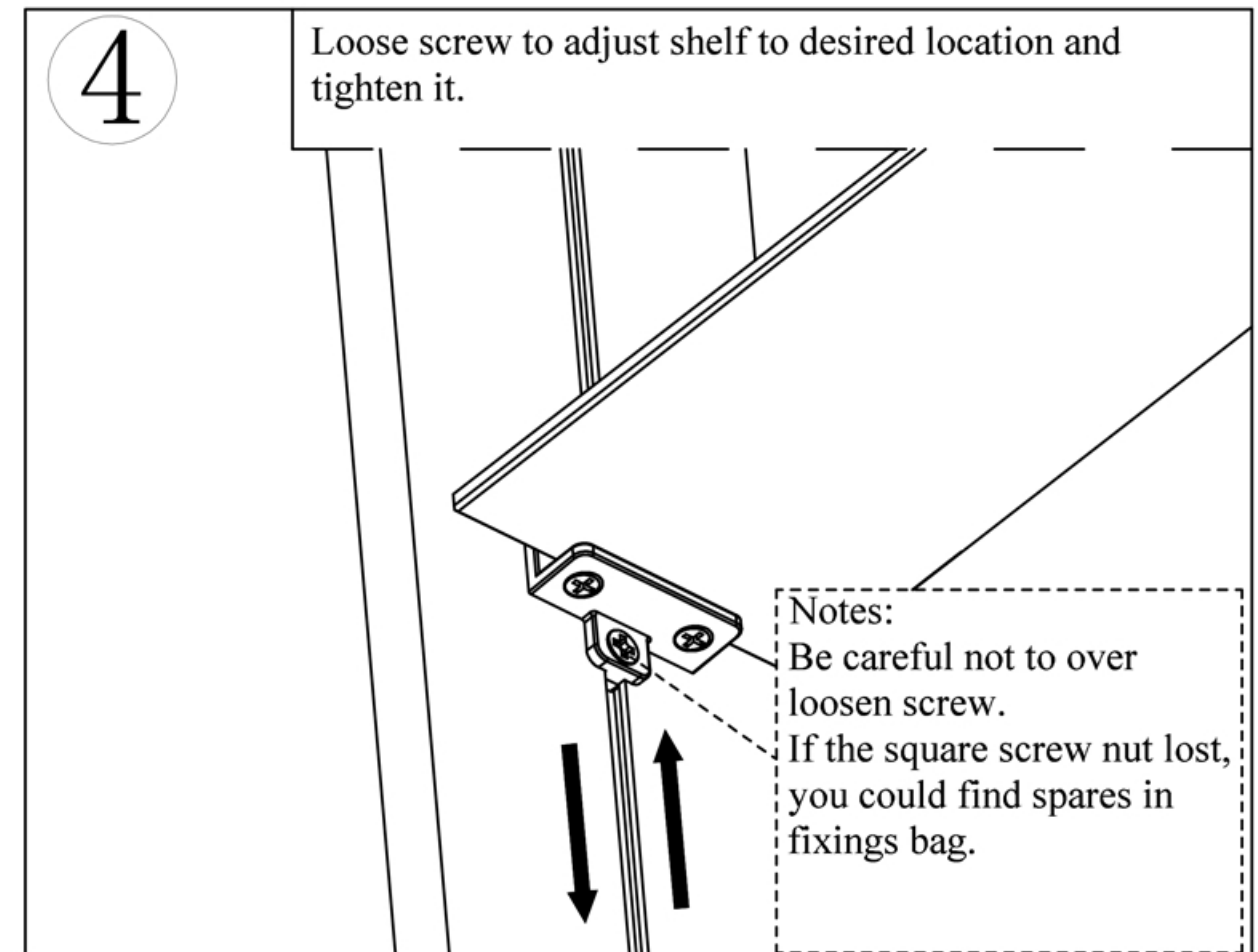
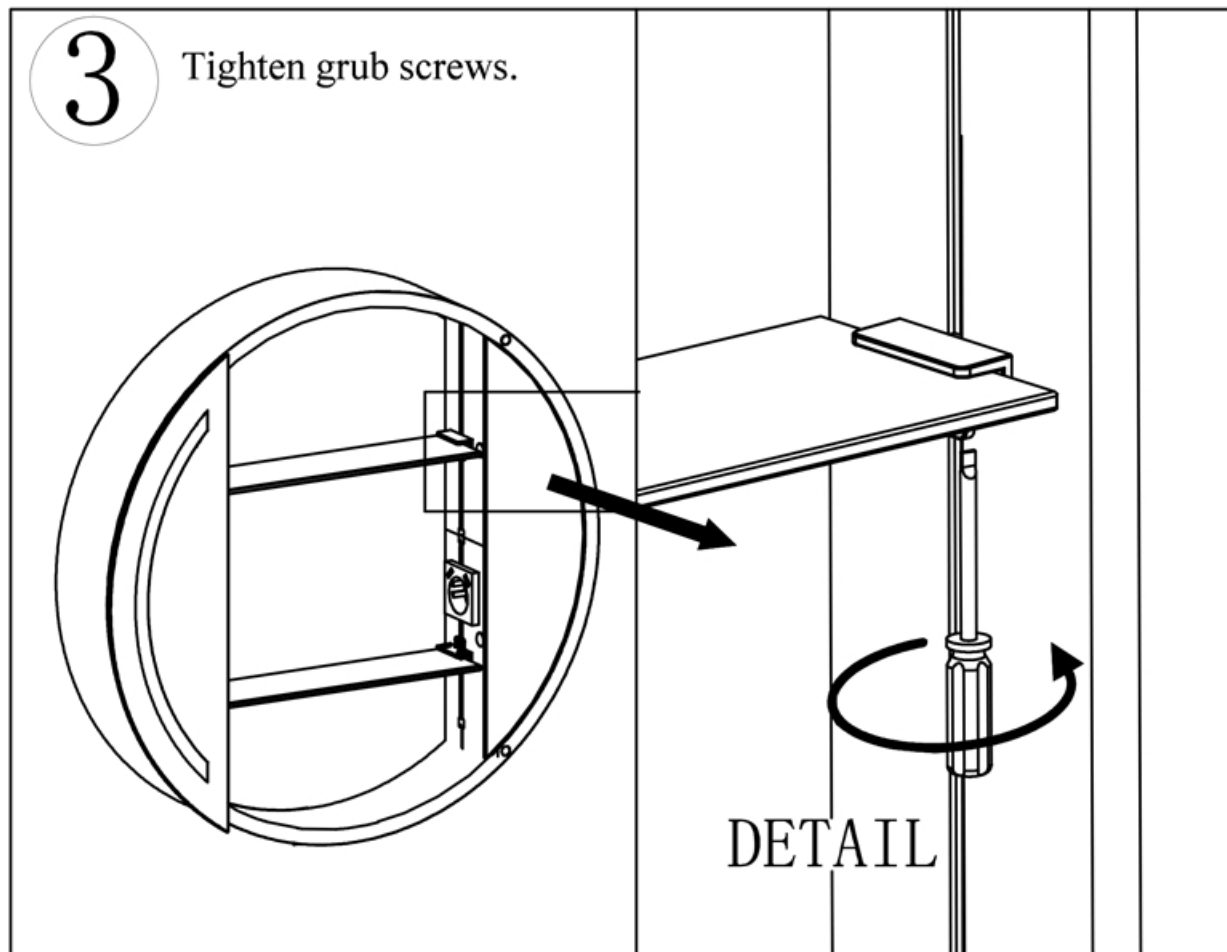
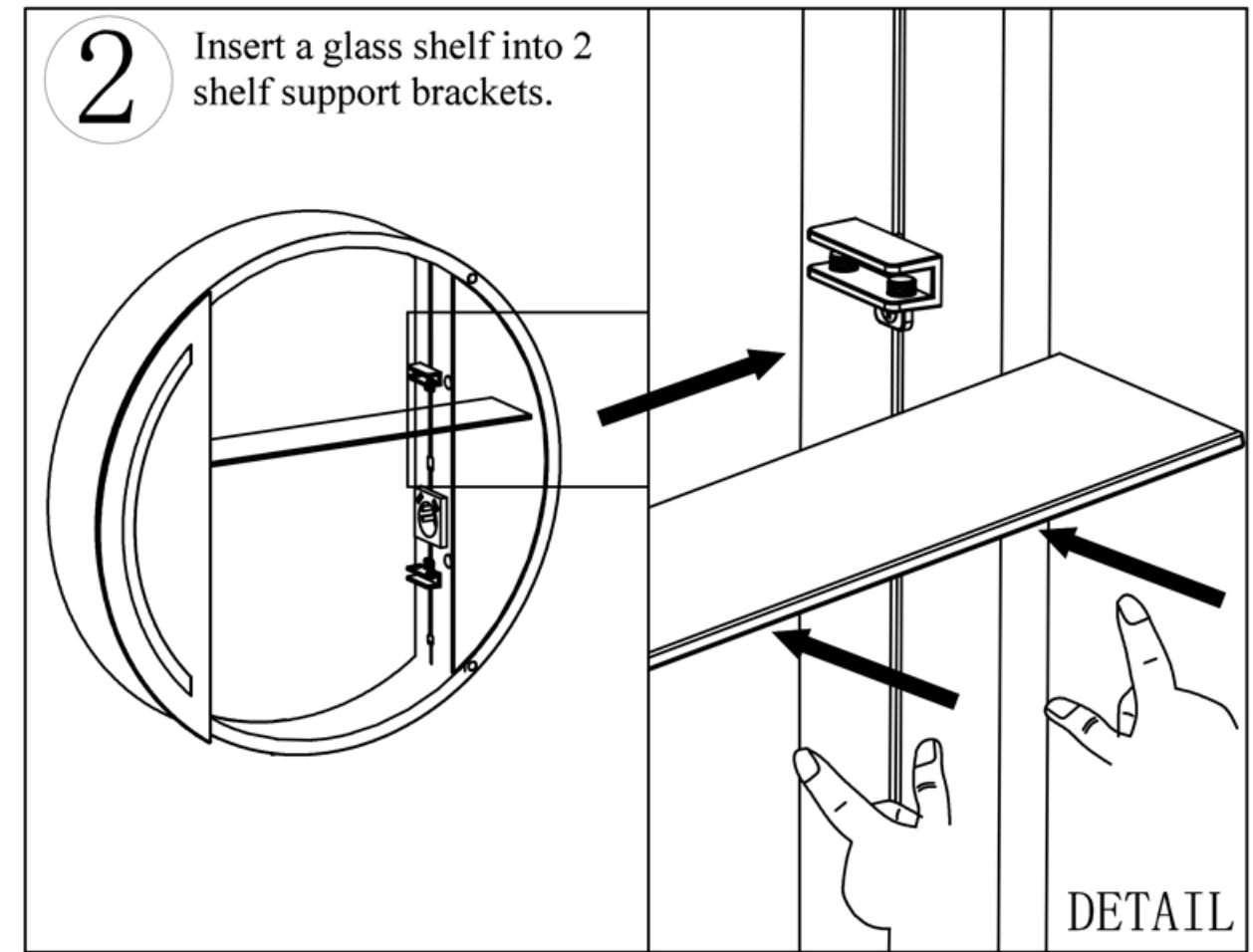
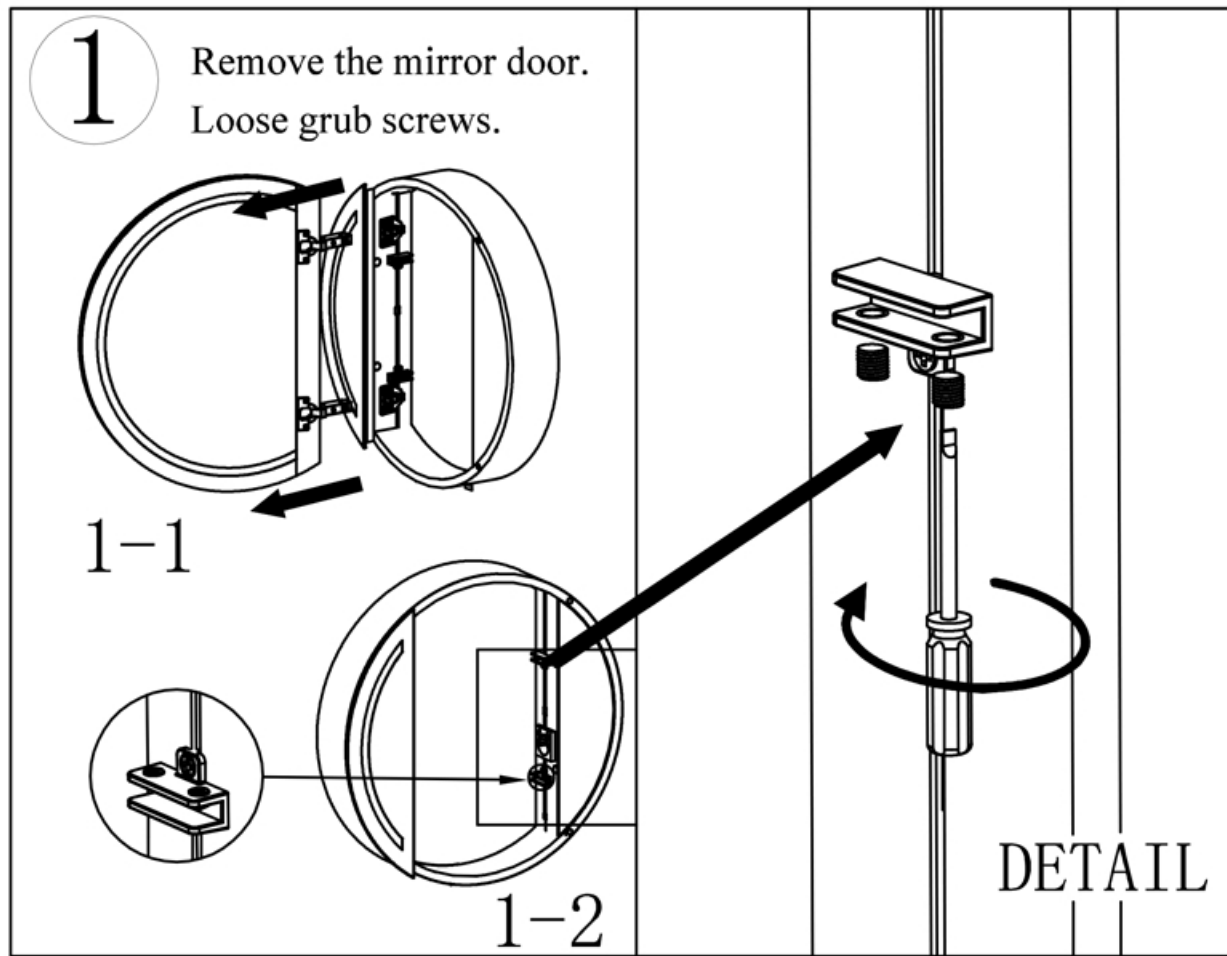

MAGNETIC STRIP INSTALLATION INSTRUCTION

① Tear the back adhesive film

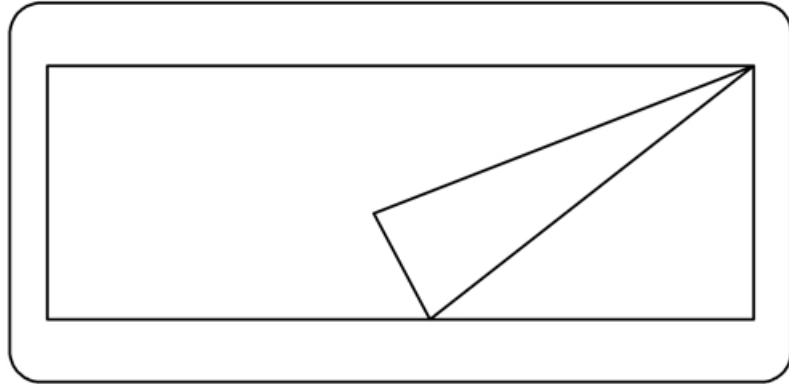

② Stick it on a suitable position

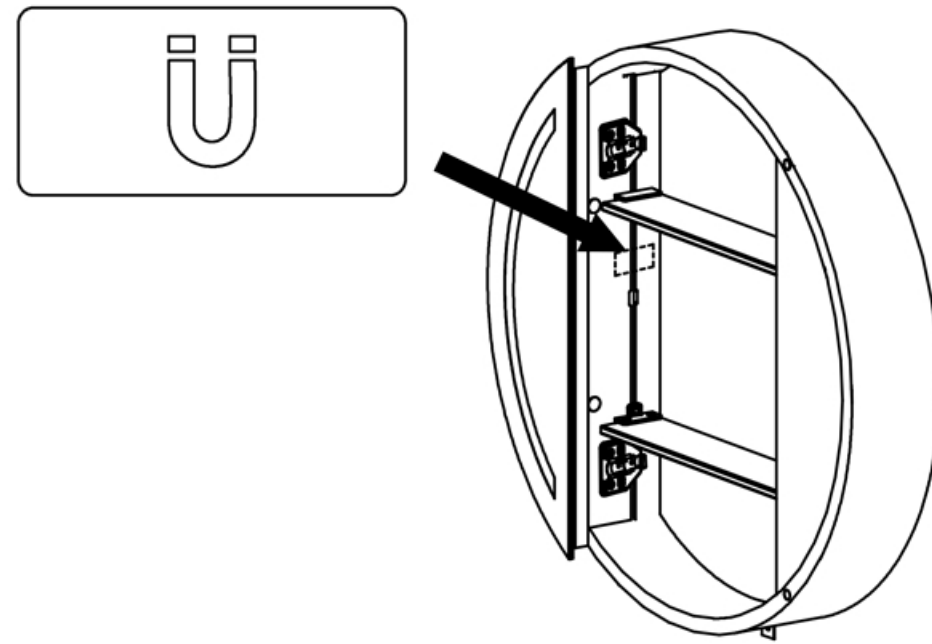

③ Press and hold after pasting

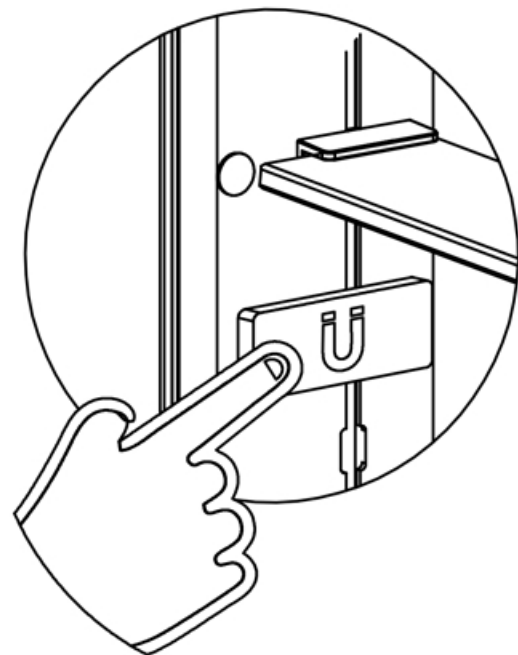

FIXING INSTRUCTIONS FOR THE MIRROR DOOR
 (STRONGLY ADVICE TO INSTALL EACH DOOR WITH 2 PERSONS)

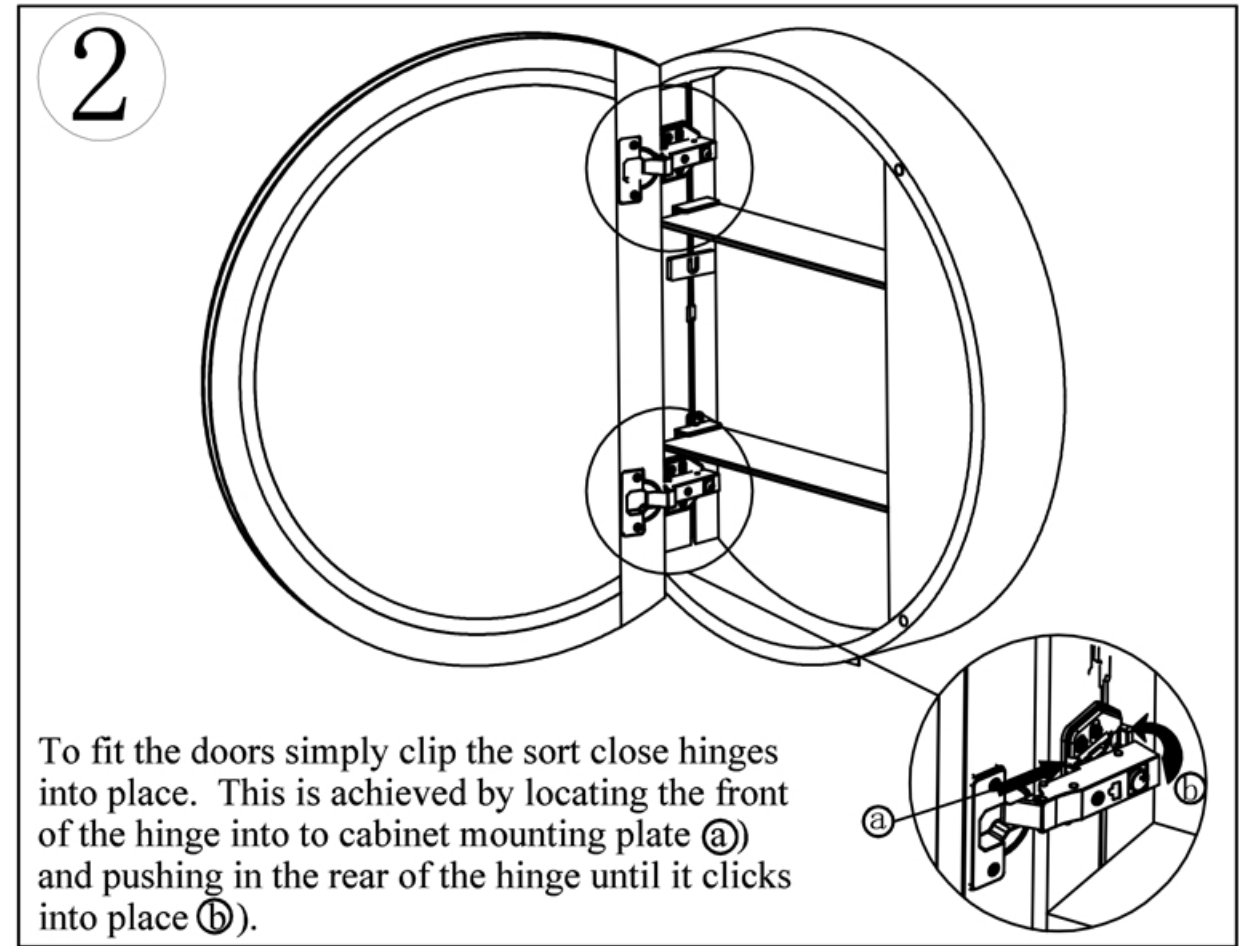
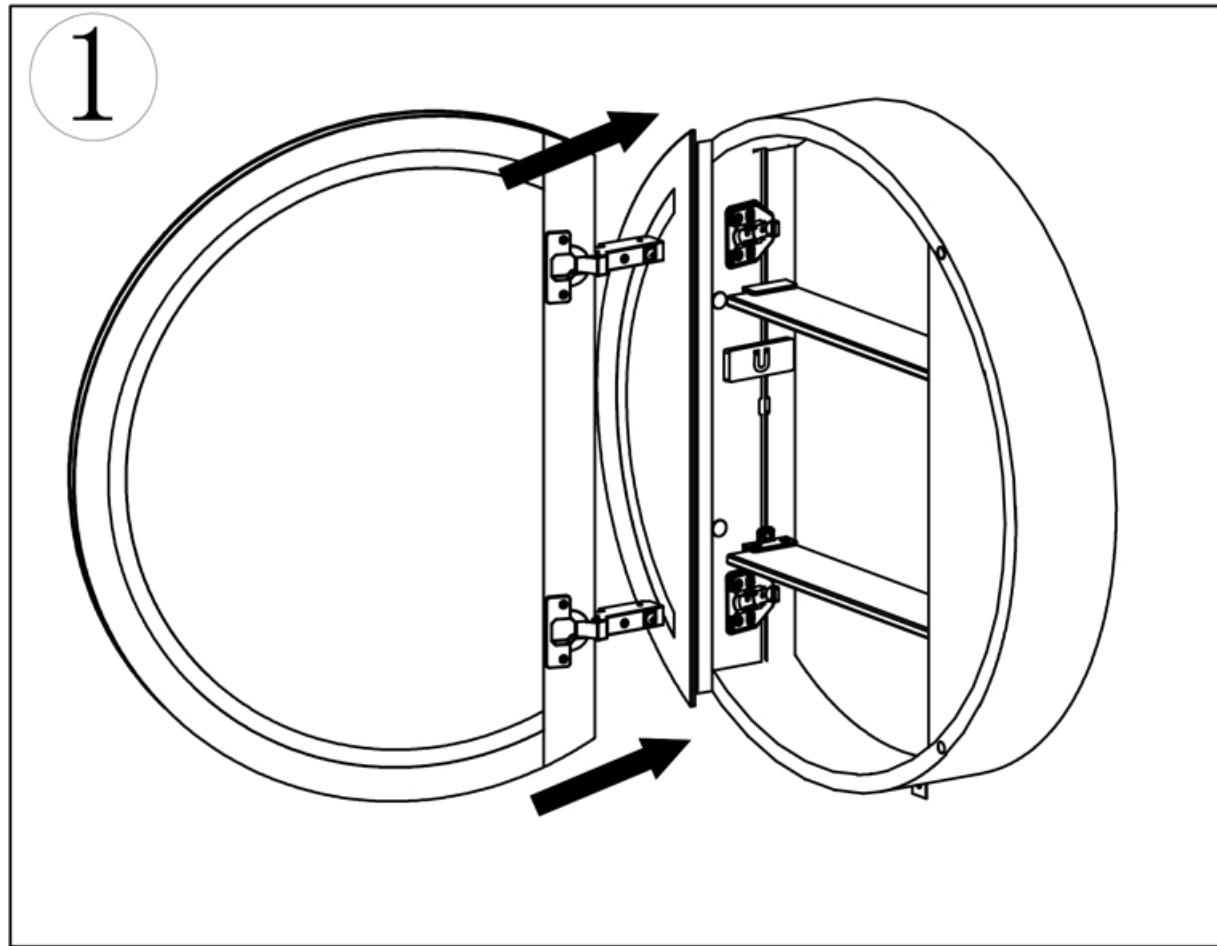

3 Door Adjustment
 There are two adjustments that can be made (a)) will adjust the door left to right (b)) will adjust the gap between the door and the cabinet.
 Once you have correctly adjusted the door(s) simply clip on the hinge cover (c)

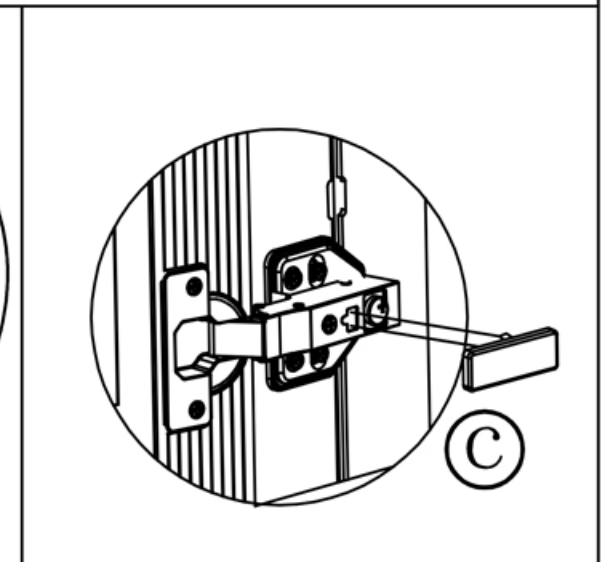
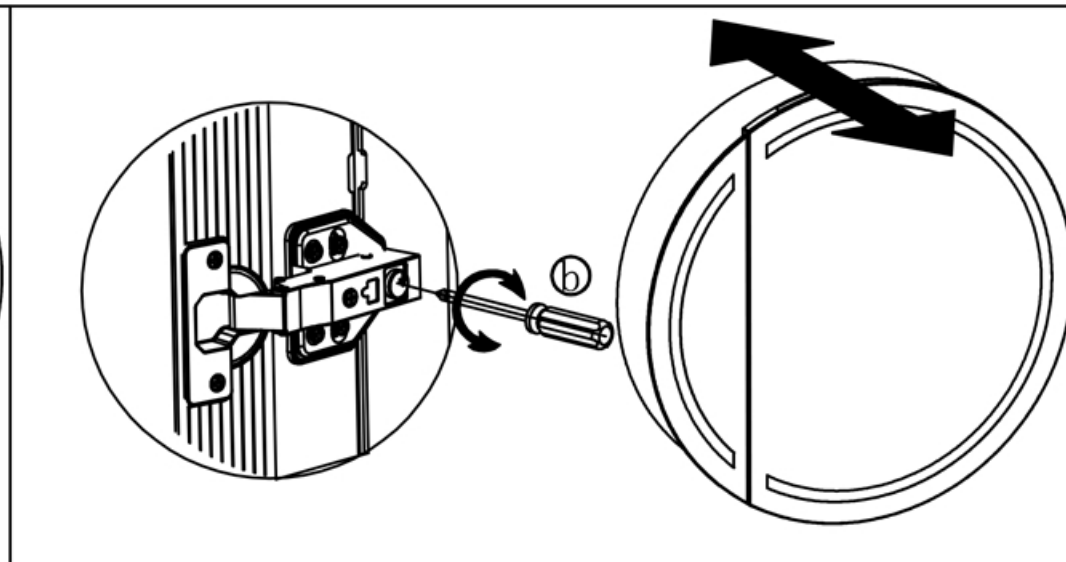
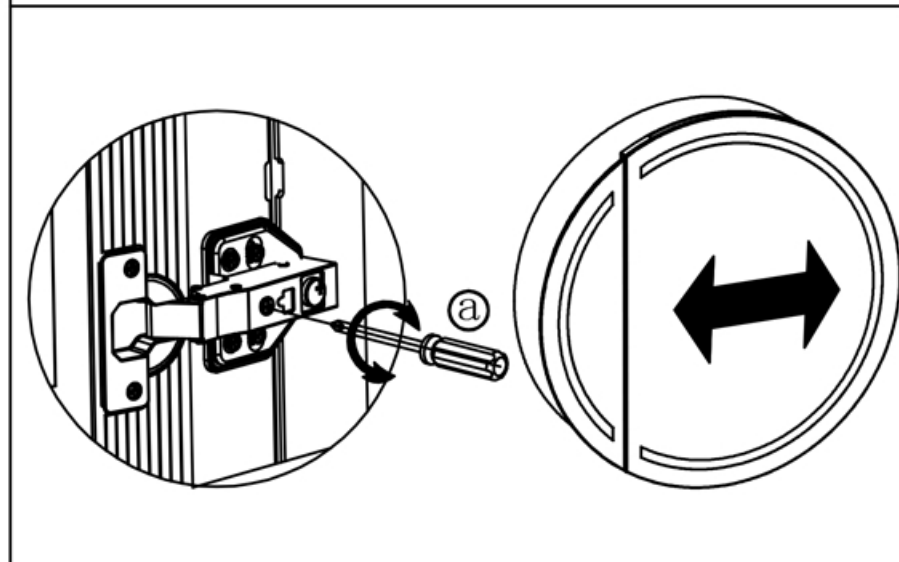

CAUTION: We recommend that you make sure the rear cable is not kinked or overlapped after installation to avoid potentially cracking the internal mirror.

